

RONGTA User Manual

RP80VI Thermal Label Printer

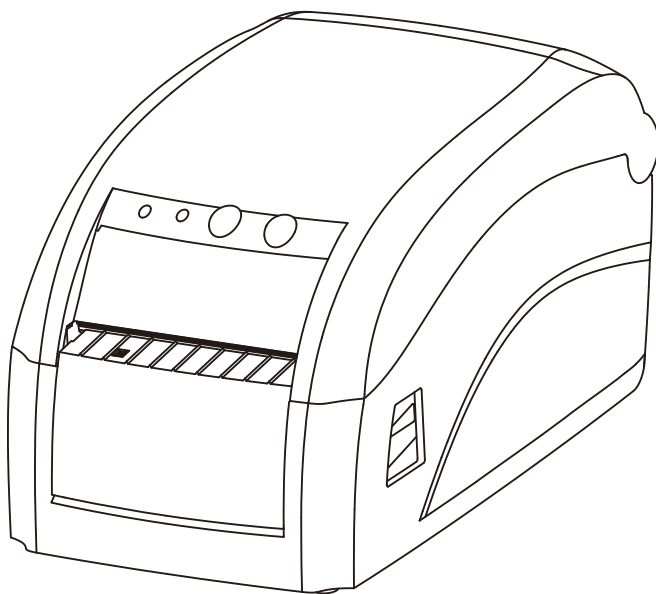

Contents

I. Product Introduction	2
1.1 Safety Warnings.....	2
1.2 Main Features.....	2
II. Safety Instructions.....	3
III. Appearance and Components.....	4
IV. Technical Parameters.....	5
4.1 Printing Parameters.....	5
4.2 Printer Indicators	6
4.3 Printer Interfaces	6
V. Installation and Operation of Printer	7
5.1 Printer Unpacking	7
5.2 Connecting the Printer	7
5.3 Loading Paper	8
5.4 Power on function.....	10
VI. The Switch, Key and Indicator Light of Printer.....	11
6.1 Power Switch.....	11
6.2 Keys and Indicators	11
6.3 Set the Printer Mode.....	13
6.4 Self-test of Printer.....	13
VII. Serial Interfaces of Printers.....	14
VIII. Parallel Interfaces of Printers.....	15
IX. USB Interface.....	16
X. Ethernet Interfaces of Printers.....	17
XI. Cashbox Interfaces of Printers.....	18
XII. Cleaning the Printer	19
12.1 Cleaning the Printer Head	19
12.2 Cleaning the Sensor.....	19
12.3 Cleaning the Printing Rubber Roller	20
XIII. Troubleshooting	21
XIV. Driver Installation.....	22
14.1 Installation for Windows	22
14.2 The Port direct drive.....	22

I. Product Introduction

Thank you for purchasing the RP80VI thermal label printer produced by our company. This thermal label printer provides you with safe, reliable and efficient printing quality at a reasonable economic price. At the same time, RP80VI is widely used in supermarkets, hospitals, restaurants, banks, gas stations, road and bridge toll collection and other fields due to its super functions and easy operation.

1.1 Safety Warnings

- ⚠ Warning:** Do not touch the paper cutting knife or paper-tearing knife of the printer.
- ⚠ Warning:** The print head is a heating component. Do not touch the print head and its surrounding components when the printer is still warm in temperature.
- ⚠ Warning:** Do not touch the surface of the thermal print head and connectors, to avoid electrostatic damage to the print head.
- ⚠ Warning:** This product is only suitable for the use in non-tropical climates.

1.2 Main Features

- High printing quality
- Low noise
- Support cashbox drive
- The attractive appearance
- Support thermal roll paper/thermal sticker/thermal label paper
- 2-6 inch/s high-speed printing
- Support QR code printing function (QR CODE)
- Meet the different needs for paper width of 16mm-82mm, and it is easy to operate.
- Auto paper calibration function
- Modular design to meet different application needs
- Low power consumption and low operation cost
- It is compatible with ESC/POS print instruction set

II. Safety Instructions

Before operating and using the printer, please carefully read the following items and strictly observe the use rules.

- ① Please install the printer on a stable surface to avoid printer suffered from any vibration and shocks.
- ② Stop using keeping the product in any case of unusual circumstances such as the presence of high temperature, high humidity and serious pollution.
- ③ Connect the printer's power adapter to an appropriate grounding socket. Avoid using the same socket with large motors or other equipment that may cause voltage fluctuation of power supply.
- ④ Do not get the product wet. Do not insert foreign objects(e.g. metal) into the product, and once it occurs, immediately turn off the power supply.
- ⑤ Never use the printer without paper, otherwise it will seriously damage the printing rubber roller and thermal head.
- ⑥ Unplug the product from the power outlet if the printer is idle for a long time.
- ⑦ Do not disassemble or modify the product personally.
- ⑧ Use only the power adapter specified in this instruction.
- ⑨ In order to ensure the printing quality and prolong the service life of the product, it is recommended to use the recommended or equivalent thermal printing paper.
- ⑩ Do not plug/unplug the product with the product powered on.
- ⑪ When plugging and unplugging the printer power cord, please hold the arrow position of the printer power connector with your hand, not the cord of the printer power cord.
- ⑫ Please keep this manual for the future use and reference.

III. Appearance and Components

Front View

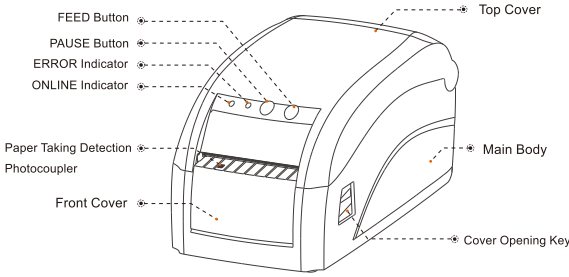

Rear View

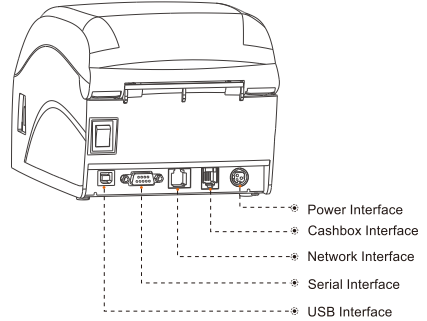

Inside View

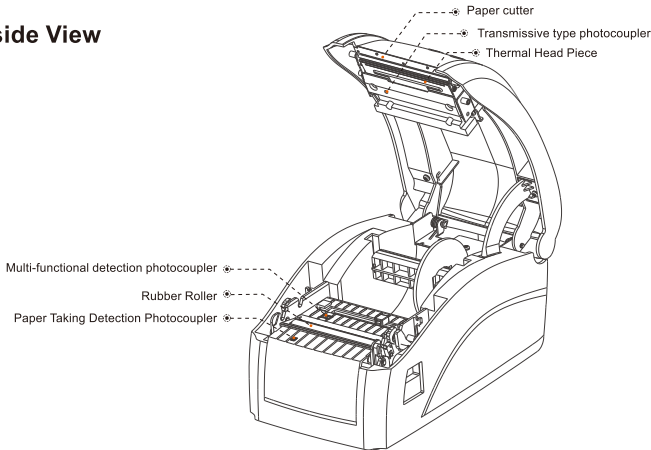

Application Field

- Cashier system of places of entertainment
- Cashier system of retail monopoly
- Catering cashier system
- Wireless Bluetooth printing cashier system
- Postal logistics receipt printing system
- Hotel receipt printing system

IV. Technical Parameters

4.1 Printing Parameters

Model	RP80VI
Printing method	Thermal line printer
Printing speed	150mm/s
Printing paper width	24-82mm
Effective resolution	203 dpi (8 dot/mm)
Outside diameter of paper roll	80mm (max)
Paper out method	Tearing off or stripping
Character size	ASCII Font A: 12x24 ASCII Font B: 9x17 Chinese character 24x24
Memory	DRAM:8M FLASH:4M
Cashbox control	Support
Print character	
ASCII character set	12x24 dot, 1.25 (width)X3.00 (height)mm
National Standard Class I and II Chinese Character Font	24x24 dot, 3.00 (width)X3.00 (height)mm
Type of bar code	One-dimensional code: Code 39、39C、125、Code 93、ITF25、EAN128、Code 128、Codabar、EAN-8、EAN8+2、EAN8+5、EAN-13EAN13+2、EAN13+5、UPC-A、UPCA+2、UPCA+5、UPC-E、UPCE+2、UPCE+5、MSIC、ITF14、EAN14、CODE11、POST QR code: QR CODE、PDF417(Optional)
Power supply	
Power adapter	AC 100 ~ 240V
Input power supply	DC 24V $\overline{\text{---}}$ 2.5A
Cashbox output	DC 24V $\overline{\text{---}}$ 1A
Service life	
Service life	The service life of print head: 50KM(label paper) 100KM(continuous paper)
Environmental requirements	
Working environment	Operating temperature: 0~45°C, operating humidity: 20~90%
Storage environment	Storage temperature: -10~60°C, storage humidity: 10~90%
Environmental conditions	
Print command	TSPL/CPCL(Customizable)/ZPL (Customizable)
Dimensions	
Weight	1.34kg

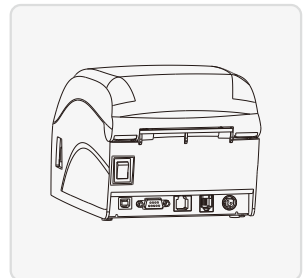
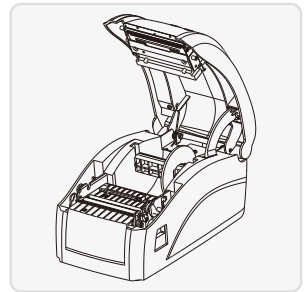
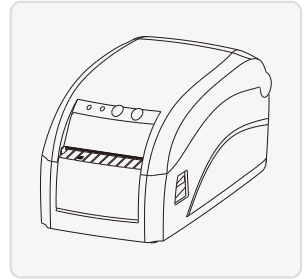





The pictures are for reference only, please subject to practicality

4.2 Printer Indicators

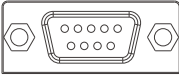
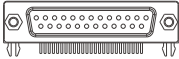
Type of printing paper Thermal paper rolls recommended	Thermal paper roll/thermal sticker/thermal label paper
Type of paper rolls	Specifications: AF50KS-E Manufacturer: Jujo Thermal Oy(Finland) Specifications: TF-50KS-E Manufacturer: Nippon Paper Industries Co., Ltd ⚠ Attention (1) To get the best results from the printer, choose the recommended paper or other paper with equivalent quality, otherwise the printing quality will be affected and even the service life of thermal print head will be reduced. (2) Please do not use the paper roll that the end glued on the core of the paper roll, otherwise it may cause damage to the printer. (3) If the printing paper is contaminated by chemicals or oils, it may fade or reduce the sensible heat degree, and affect the printing effect. (4) Do not rub the surface of the printing paper with hard articles, otherwise it may cause fading. (5) The print paper will fade if the temperature is up to 70°C,keep it out of direct sunlight, humidity and high temperature.

4.3 Printer Interfaces

Diagram	Type	Illustration
	USB	Universal USB Interface (Standard Type B).
	Serial interface	Db9 female connector interface, communication baud rate is 4800bps, 9600bps, 19200bps or 38400bps optional (adjusting via DIP switch), data structure is parity-free, 8-bit data bit, 1-bit stop bit; RTS/CTS and XON/XOFF handshake protocols are supported.
	Parallel interface (25PIN)	25PIN Parallel (male connector) bidirectional parallel interface, 8-bit parallel interface, support BUSY/nAck handshake protocol 8.
	Network interface	Standard RJ45-8P interface, 10M/100M transmission speed with self-adaptation, 100M network LED indication, data communication LED indication.
	Cashbox control	The 6-wire RJ-11 socket, outputing DC 24V/1A power signal to drive the cashbox.
	Power interface	Power plug DC 24V.

⊙ **Note:** The interface is optional or customized, and the specific interface is subject to the actual object.

V. Installation and Operation of Printer

5.1 Printer Unpacking

Check the parts:

Before use, make sure the accessories are included in the package(the following picture is an example). If any thing is missing, contact the supplier or manufacturer. The specific accessories may not be included depending on the printer model.

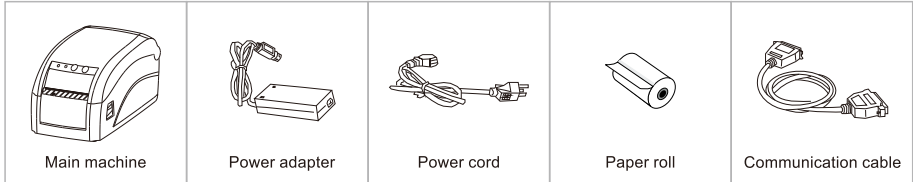

☺ The pictures are for reference only, please subject to practicality.

5.2 Connecting the Printer

- (1) Make sure that both the printer and the PC host are turned off, plug the matching data communication cable into the printer's data interface, and plug the other end into the serial port/parallel port /USB/ network port of PC host.
- (2) If equipped with an electrically openable cashbox, insert the RJ-11 connector on the cashbox into the cashbox interface of the printer (the specifications of the cashbox must conform to the printer cashbox drive specifications).
- (3) Connect to the special power adapter of the printer.

Use the special power adapter for the printer.

The connection diagram is as follows:

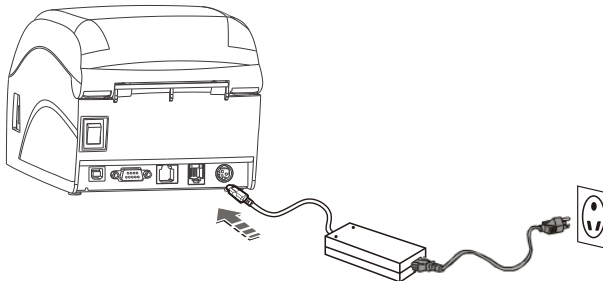

Attention:

- (1) First plug the power plug DC24V of the printer, then switch on the AC220V power supply, and then turn on the power switch. Do not reverse the sequence, otherwise the machine will be damaged.
- (2) Using an improper power adapter will make the printing quality worse and even damage the printer.
- (3) Do not connect the telephone line to the cashbox interface, otherwise the printer and telephone may be damaged.
- (4) When plugging in the printer power cord, please hold the arrow position of the printer power connector with your hand (do not plug in the cord of the printer power cord with your hand). Forcibly plucking the flexible cord of the printer power connector or pulling the printer power cord may cause damage to the printer or the power adapter.

5.3 Loading Paper

RP80VI thermal label printer uses 80mm thermal paper roll.

5.3.1 The label paper loading steps under stripping mode are as follows:

- (1) Press the cover opening key to open the top cover.
- (2) Keep the label paper on the far left with the stopper.
- (3) Remove the front cover and press down the lever.
- (4) Pass the label paper between the stripping roller and the rubber roller (refer to "Label paper loading guide under stripping mode" figure for details)

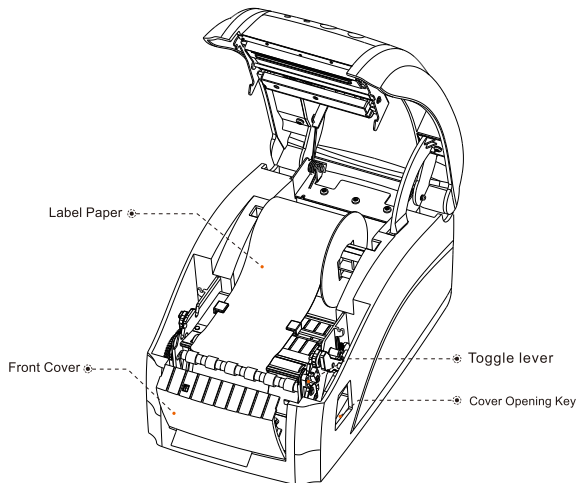

The "Label paper loading guide under stripping mode" figure is as follows:

☐ Correct method

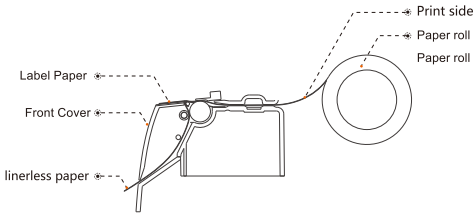

☐ Wrong method 1

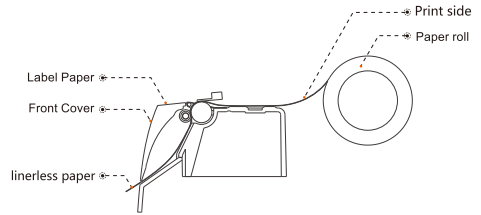

☐ Wrong method 2

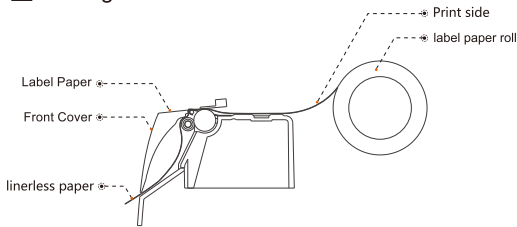

5.3.2 The plain paper loading steps are as follows:

- (1) Press the cover opening key to open the top cover.
- (2) Keep the label paper on the far left with the stopper.
- (3) Pass the front end of the paper roll through the paper guide and pull it out beyond the rubber roller; close the paper guide to fix the two sides of the paper according to the paper width.
- (4) Close the upper cover of printer and press down gently until the top cover closes with a "click" sound.

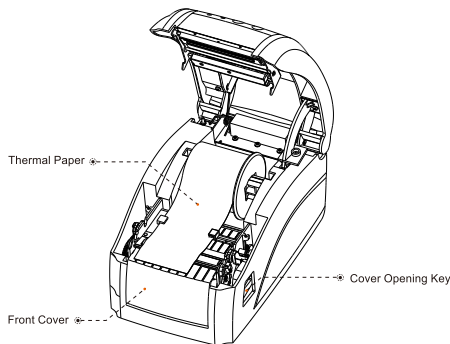

The plain paper loading guide figure is as follows

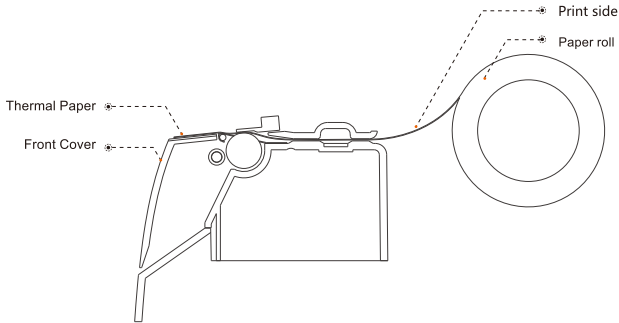

5.4 Power on function

Gap sensor calibration

The sensitivity of the gap sensor must be calibrated under the following conditions:

- (1) Brand new printer.
- (2) Change of label material;
- (3) Initialization of printer.

This function is used to calibrate the sensitivity of label paper gap sensor after the printer is started. When the user loads a paper roll of a different specification or restores the printer to the factory settings, the label paper gap sensor must be calibrated.

Following the following steps to perform gap sensor calibration:

- (1) Turn off printer power.
- (2) Make sure the printer is loaded with paper and close the top cover.
- (3) Press and hold the PAUSE button and turn on the printer at the same time, and the printer will automatically calibrate the sensitivity of the gap sensor and write the parameters to the memory; then, release the PAUSE button.

Printer initialization

The printer initialization function clears the downloaded data from the internal memory (DRAM) and restores the parameters to the factory settings. Please calibrate the gap sensor after initialization.

VI. The Switch, Key and Indicator Light of Printer

6.1 Power Switch

The power switch controls the flow of power to the printer. The power switch is located on the left side of the printer. When the "-" switch is pressed, the printer is turned on; When the "O" of the switch is pressed, the printer is turned off.

⚠ Attention: Make sure the power supply is connected before turning on the printer.

6.2 Keys and Indicators

The keys and indicator panel as shown in the following figure:

The function description of keys and indicators:

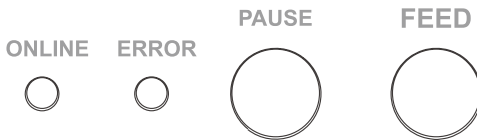

FEED key

Press the FEED button once to advance paper or hold down the FEED button to feed paper continuously. Hold down the FEED button and turn on the product at the same time to print the self-test.

PAUSE key

When the printer is printing, press PAUSE button and the printer will stop working.

ONLINE indicator (blue)

When connected to the power supply, it always lights up; when connected with WIFI interface, it blinks when not connected successfully; and when connected successfully, it always lights up.

ERROR indicator (red)

The ERROR indicator will flashing when occur paper shortage, paper jam, printer head overheating, print head error or other abnormalities.

6.2.1 Indicator

Serial Number	Indicator Status	Function Description
1	The POWER indicator is always on and the ERROR indicator is off.	The printer is on and in normal printing state.
2	The POWER indicator is always on and the ERROR indicator flashes.	Error occurs, Please refer to the error code for details.

6.2.2 Error code

Code	Buzzer Prompt	Function Description
1	One beep sound when starting the printer	Printer initialization completed
2	Two continuous beeps	Printer mechanism not connected
3	Three continuous beeps	Paper shortage
4	Four continuous beeps	Diffusion knife error
5	Five continuous beeps	Overheating
6	Six continuous beeps	Cover is open
7	Eight continuous beeps	Seam label detection error
8	Nine continuous beeps	External RAM detection error
9	Ten continuous beeps	External FLASH detection error

6.2.3 Button

Serial Number	Function	Description
1	Feed	When the POWER indicator is always on and the ERROR indicator is off, press FEED button and the printer will feed the paper to the front of next label paper.
2	Pause	When the printer is printing, press PAUSE button and the printer will stop working.
3	Gap sensor calibration	<ol style="list-style-type: none">1. Turn off the printer.2. Make sure the printer is loaded with paper and close the printer top cover.3. Press and hold PAUSE button and turn on the printer at the same time, and the printer will automatically calibrate the sensitivity of the gap sensor and write the parameters to the memory; then, release the PAUSE button.
4	Enter debug mode	<ol style="list-style-type: none">1. Turn off the printer2. Make sure the printer is loaded with paper and close the printer top cover3. Press and hold the PAUSE button and FEED button at the same time, and then turn on the printer. When the POWER indicator (blue) and ERROR indicator (red) are on at the same time, release the PAUSE button and FEED button, and the printer enters the debug mode.

6.3 Set the Printer Mode

The default value is set when the RP8VI thermal label printer leaves the factory. However, the settings can be changed for the special needs of users. Use the DIP switch at the bottom of the printer to adjust the printer settings.

The setting functions of each DIP switch are as follows:

Switch	Function	On	Off
1	Diffusion knife	Without diffusion knife	With diffusion knife
2	Beep prompt	Turn on the beep prompt	Turn off the buzzer prompt
3	Print concentration	High concentration	Normal concentration
4	24-bit character mode	No Chinese characters	Have Chinese characters
5	Print characters per line (characters)	42	48
6	Choose the cashbox	Open the cashbox	Close the cashbox
7-8	Transmission speed (the serial port is valid)		
refer to the table below			
Transmission speed (bps)- bits/sec		SW-7	SW-8
9600		ON	OFF
19200		OFF	OFF
38400		ON	ON
115200		OFF	ON

6.4 Self-test of Printer

Self-test can detect whether the printer is working normally. If the Self-test list sample can be printed correctly, it indicates that everything is normal except the connection interface with the host computer, otherwise overhaul is required. In the self-test, it will print the software version number, print density, interface type, English characters and some Chinese characters in sequence.

The operation method of self-test is: after the printer is connected, press and hold the feed key first and then turn on the power supply of the printer. First, the printer will reset and detect, and release the feeding button less than 5 seconds after the reset is completed. At this moment, the printer will carry out self-test and print the self-inspection list sample.

VII. Serial Interfaces of Printers

The serial interface of RP80VI thermal label printer adopts RS-232 standard. The communication baud rate is 4800bps, 9600bps, 19200bps or 38400bps optional (adjusting via DIP switch). It is parity-free, 8-bit data bit, 1-bit stop bit; RTS/CTS and XON/XOFF handshake protocols are supported.

The functions of each pin of the printer serial interface are defined as follows:

Pin number	Model	Signal source	Description
2	TXD	Printer	The printer sends data to the host.
3	RXD	Host	The printer receives data from the host.
8	RTS	Printer	This signal reflects the current status of printer. A high electrical level indicates that the printer is "busy" and cannot receive data, while a low electrical level indicates that the printer is "ready" and can receive data.
5	GND	-----	Signal ground
6	DTR	Printer	Same as RTS signal (pin 8).

Schematic diagram of connection between printer serial interface and POS host serial interface:

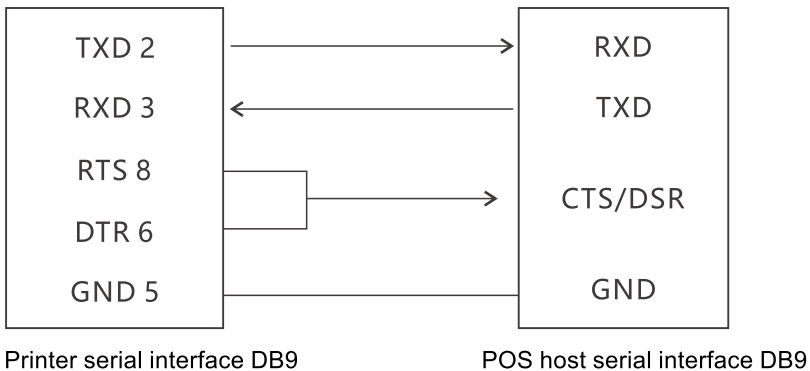

VIII. Parallel Interfaces of Printers

The parallel interface socket of the RP80VImm thermal label printer is a 25PIN parallel socket with 8-bit parallel transmission, it supports BUSY/nAck handshake protocol (subject to the actual object).

The functions of each pin of printer parallel interface socket are defined as follows:

Number of 25 PIN	Number of 36 PIN	Signal name	Signal source	Description
1	1	/STB	Host	Data strobe trigger pulse, read data at falling edge
2	2	DATA2	Host	These signals respectively represent the first to eighth bit information of parallel data. The signal is "high" electrical level when the logic is "1" and "low" electrical level when the logic is "0".
3	3	DATA3	Host	
4	4	DATA4	Host	
5	5	DATA5	Host	
6	6	DATA6	Host	
7	7	DATA7	Host	
8	8	DATA8	Host	
9	9	DATA9	Host	
10	10	nAck	Printer	Printer response signal. It indicates that the printer has received the data of previous byte
11	11	BUSY	Printer	"High" electrical level indicates that the printer is "busy" and cannot receive data.
12	12	Paper-out	-----	It indicates whether there is a paper shortage Paper-out PE.
13	13	Select	Printer	Pull up electrical level to "high" by resistor
18-25	16-17	GND	-----	Ground, logic "low" electrical level
	19-30	GND	-----	Ground, logic "low" electrical level
	33	GND	-----	Ground, logic "low" electrical level
15	32	NError(nFault)	Printer	Pull up electrical level to "high" by resistor

IX. USB Interface

The printer's USB interface socket is standard USB type-B

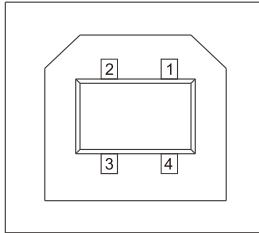

PIN	SIGNAL NAME
1	VBUS
2	D-
3	D+
4	GND

X. Ethernet Interfaces of Printers

The Ethernet interface socket of RP80VI thermal label printer is standard RJ45-8P, it supports 10M/100M network, and the transmission speed is adaptive.

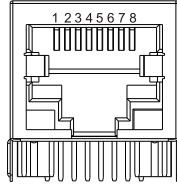

Pin number	Description	Illustration
1	TX+	Send differential line+
2	TX-	Send differential line-
3	RX+	Receive differential line+
4	NC	No function
5	NC	No function
6	RX-	Receive differential line-
7	NC	No function
8	NC	No function

XI. Cashbox Interfaces of Printers

The cashbox interface of the printer adopts RJ-11 standard, 6-wire socket, and outputs DC 24V/1A power signal to drive the cashbox. Insert the RJ-11 crystal connector of the cashbox into the cashbox interface to open the cashbox through the printer.

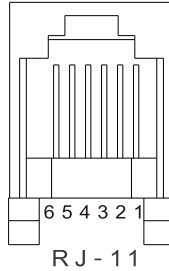

The functions of each pin of the cashbox interface of the printer are defined as follows:

Pin number	Signal	Description
1	GND	Power supply ground
2	Dk1	Negative pole of cashbox 1#
3	DK-1N	Start detection
4	PWR	Positive pole of power supply/cashbox
5	Dk2	Negative pole of cashbox 2#
6	GND	Power supply ground

XII. Cleaning the Printer

12.1 Cleaning the Printer Head

Clean the print head when one of the following conditions occurs to the printer:

- (1) Printing is not clear;
- (2) A vertical column of the printed page is not clear;
- (3) The paper feeding noise is high.

The print head cleaning steps are as follows:

- (1) Disconnect the power cord, open the upper cover and remove the paper if exists.
- (2) If printing has just been completed, wait for the print head to cool completely;
- (3) Clean the printer head with a soft cotton moistened with ethyl alcohol.
- (4) After waiting for absolute ethyl alcohol to volatilize completely, close the cover and try printing again.

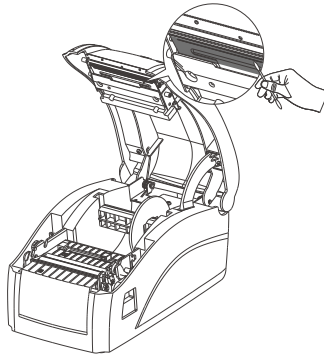

12.2 Cleaning the Sensor

Clean the paper shortage sensor when one of the following conditions occurs to the printer:

- (1) In the printing process, the printer occasionally stops printing and alarms for paper shortage;
- (2) It does not give alarms for paper shortage.

The paper shortage sensor cleaning steps are as follows:

- (1) Turn off the power supply of the printer, open the upper cover, and remove the paper if there is any;
- (2) Wipe off the dust and stain on the sensor surface with soft cotton cloth (which should be dried) dipped in absolute ethyl alcohol.
- (3) After waiting for absolute ethyl alcohol to volatilize completely, close the cover and try to start the machine again.

12.3 Cleaning the Printing Rubber Roller

When one of the following conditions occurs to the printer, the printing rubber roller should be cleaned:

- (1) Printing is not clear;
- (2) A vertical column of the printed page is not clear;
- (3) The paper feeding noise is high.

The printing Rubber Rollers cleaning steps are as follows:

- (1) Turn off the power of the printer and open the upper cover;
- (2) Use a soft cotton cloth (which should be dried) dipped in a neutral detergent to wipe off dust and stains on the surface of the printing rubber roller;
- (3) Close the upper cover after the cleaning agent is completely volatilized.

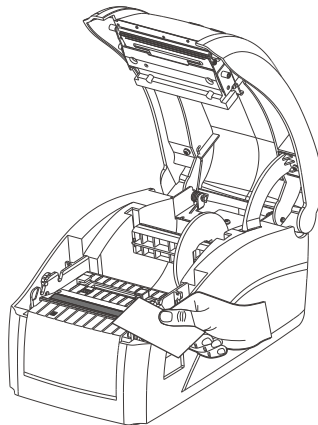

⚠ Attention:

- (1) The power supply must be turned off during the daily maintenance of the printer.
- (2) Do not touch the surface of the print head with hands and metal objects, and do not scratch the surface of the print head, printing rubber roller and sensor with tweezers and other tools.
- (3) The organic solvents such as gasoline and acetone shall not be used.
- (4) Wait until absolute ethyl alcohol is completely volatilized, then turn on the power supply to continue printing.

XIII. Troubleshooting

When the printer fails, it can be handled according to the method in this section. If the problem cannot be solved, please contact the distributor or manufacturer.

13.1 The indicator on the control panel is not on

Check whether the power cord is properly plugged into the printer, power adapter, and power outlet or not. Check if the printer's power switch is on.

13.2 The indicator is normal, while the printer does not work

Run the self-test to check whether the printer can work properly. If you cannot perform self-test, please contact your distributor or the technical service personnel.

If the self-test can be performed normally, check the following:

- (1) Check the interfaces at both ends of the connection line between the printer and the computer. At the same time, confirm whether the connection meets the specifications of printer and computer.
- (2) The data transfer settings between the printer and the computer may be different. You can use self-test to print out the printer's interface settings. If the printer cannot print, please contact your distributor or the technical service personnel.

XIV. Driver Installation

There are two ways to drive the RP80VI thermal label printer, one is to install the driver directly under Windows 9X/7/8/10/ME/2000/XP/Linux/MAC, the other is to use the port for direct driving.

14.1 Installation for Windows

Add the printer to Windows and assign the driver files in the driver disk to Windows. You can start printing only by calling the print command in the program. In this way, the printer driver of Windows actually converts characters into graphic dot matrix for printing.

14.2 The Port direct drive

In this way, there is no need to use a driver, only the characters need to be directly output to the port, and the built-in and cartridge font inside the printer is used to realize the conversion and printing of the characters. Using the port direct drive way, the printing mode is also changed from page printing mode to line printing mode, making printing control more convenient.



Rongta Technology (Xiamen) Group Co., Ltd.

ADD: No.88, Tonghui South Road, Tongan, Xiamen, China.

WEB: www.rongtatech.com

TEL: 0086-592-5666129 FAX: 0086-592-5659169

